

Micropower Voltage Reference Diodes

LM285, LM385B

The LM285/LM385 series are micropower two-terminal bandgap voltage regulator diodes. Designed to operate over a wide current range of 10 μ A to 20 mA, these devices feature exceptionally low dynamic impedance, low noise and stable operation over time and temperature. Tight voltage tolerances are achieved by on-chip trimming. The large dynamic operating range enables these devices to be used in applications with widely varying supplies with excellent regulation. Extremely low operating current make these devices ideal for micropower circuitry like portable instrumentation, regulators and other analog circuitry where extended battery life is required.

The LM285/LM385 series are packaged in a low cost TO-226 plastic case and are available in two voltage versions of 1.235 V and 2.500 V as denoted by the device suffix (see Ordering Information table). The LM285 is specified over a -40°C to $+85^{\circ}\text{C}$ temperature range while the LM385 is rated from 0°C to $+70^{\circ}\text{C}$.

The LM385 is also available in a surface mount plastic package in voltages of 1.235 V and 2.500 V.

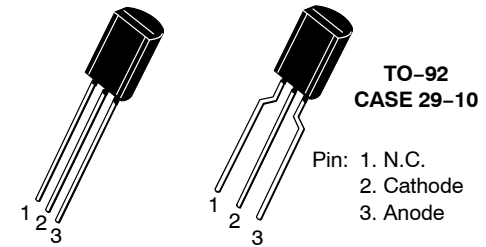
Features

- Operating Current from 10 μ A to 20 mA
- 1.0%, 1.5%, 2.0% and 3.0% Initial Tolerance Grades
- Low Temperature Coefficient
- 1.0 Ω Dynamic Impedance
- Surface Mount Package Available
- These Devices are Pb-Free and are RoHS Compliant

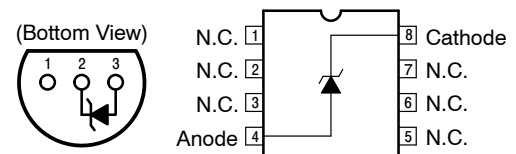


Figure 1. Representative Schematic Diagram

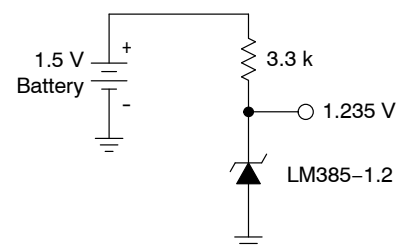
MARKING DIAGRAMS



- xxx = 1.2 or 2.5
 y = 2 or 3
 z = 1 or 2
 A = Assembly Location
 L = Wafer Lot
 Y = Year
 W = Work Week
 ■ = Pb-Free Package
 (Note: Microdot may be in either location)



Standard Application



ORDERING INFORMATION

See detailed ordering and shipping information on page 6 of this data sheet.

LM285, LM385B

MAXIMUM RATINGS (T_A = 25°C, unless otherwise noted)

| Rating | Symbol | Value | Unit |
|---|------------------|------------------------|------|
| Reverse Current | I _R | 30 | mA |
| Forward Current | I _F | 10 | mA |
| Operating Ambient Temperature Range | T _A | -40 to +85 0 to +70 | °C |
| Operating Junction Temperature | T _J | +150 | °C |
| Storage Temperature Range | T _{stg} | -65 to +150 | °C |
| Electrostatic Discharge Sensitivity (ESD) Human Body Model (HBM) Machine Model (MM) Charged Device Model (CDM) | ESD | 4000 400 2000 | V |

Stresses exceeding those listed in the Maximum Ratings table may damage the device. If any of these limits are exceeded, device functionality should not be assumed, damage may occur and reliability may be affected.

ELECTRICAL CHARACTERISTICS (T_A = 25°C, unless otherwise noted)

| Characteristic | Symbol | LM285-1.2 | | | LM385-1.2/LM385B-1.2 | | | Unit |
|---|-------------------------|----------------|------------|------------------------|----------------------|------------|------------------------|---------|
| | | Min | Typ | Max | Min | Typ | Max | |
| Reverse Breakdown Voltage (I _{Rmin} ≤ I _R ≤ 20 mA) LM285-1.2/LM385B-1.2 T _A = T _{low} to T _{high} (Note 1) LM385-1.2 T _A = T _{low} to T _{high} (Note 1) | V _{(BR)R} | 1.223 1.200 | 1.235 - | 1.247 1.270 | 1.223 1.210 | 1.235 - | 1.247 1.260 | V |
| Minimum Operating Current T _A = 25°C T _A = T _{low} to T _{high} (Note 1) | I _{Rmin} | - - | 8.0 - | 10 20 | - - | 8.0 - | 15 20 | μA |
| Reverse Breakdown Voltage Change with Current I _{Rmin} ≤ I _R ≤ 1.0 mA, T _A = +25°C T _A = T _{low} to T _{high} (Note 1) 1.0 mA ≤ I _R ≤ 20 mA, T _A = +25°C T _A = T _{low} to T _{high} (Note 1) | ΔV _{(BR)R} | - - | - - | 1.0 1.5 10 20 | - - | - - | 1.0 1.5 20 25 | mV |
| Reverse Dynamic Impedance I _R = 100 μA, T _A = +25°C | Z | - | 0.6 | - | - | 0.6 | - | Ω |
| Average Temperature Coefficient 10 μA ≤ I _R ≤ 20 mA, T _A = T _{low} to T _{high} (Note 1) | ΔV _{(BR)R} /ΔT | - | 80 | - | - | 80 | - | ppm/°C |
| Wideband Noise (RMS) I _R = 100 μA, 10 Hz ≤ f ≤ 10 kHz | n | - | 60 | - | - | 60 | - | μV |
| Long Term Stability I _R = 100 μA, T _A = +25°C ± 0.1°C | S | - | 20 | - | - | 20 | - | ppm/kHR |
| Reverse Breakdown Voltage (I _{Rmin} ≤ I _R ≤ 20 mA) LM285-2.5/LM385B-2.5 T _A = T _{low} to T _{high} (Note 1) LM385-2.5 T _A = T _{low} to T _{high} (Note 1) | V _{(BR)R} | 2.462 2.415 | 2.5 - | 2.538 2.585 | 2.462 2.436 | 2.5 - | 2.538 2.564 | V |
| Minimum Operating Current T _A = 25°C T _A = T _{low} to T _{high} (Note 1) | I _{Rmin} | - - | 13 - | 20 30 | - - | 13 - | 20 30 | μA |

- T_{low} = -40°C for LM285-1.2, LM285-2.5
 T_{high} = +85°C for LM285-1.2, LM285-2.5
 T_{low} = 0°C for LM385-1.2, LM385B-1.2, LM385-2.5, LM385B-2.5
 T_{high} = +70°C for LM385-1.2, LM385B-1.2, LM385-2.5, LM385B-2.5

LM285, LM385B

ELECTRICAL CHARACTERISTICS (T_A = 25°C, unless otherwise noted)

| Characteristic | Symbol | LM285-1.2 | | | LM385-1.2/LM385B-1.2 | | | Unit |
|---|------------------------|-----------|-----|-----|----------------------|-----|-----|---------|
| | | Min | Typ | Max | Min | Typ | Max | |
| Reverse Breakdown Voltage Change with Current I _{Rmin} ≤ I _R ≤ 1.0 mA, T _A = +25°C T _A = T _{low} to T _{high} (Note 2) 1.0 mA ≤ I _R ≤ 20 mA, T _A = +25°C T _A = T _{low} to T _{high} (Note 2) | ΔV _{(BR)R} | - | - | 1.0 | - | - | 2.0 | mV |
| | | - | - | 1.5 | - | - | 2.5 | |
| | | - | - | 10 | - | - | 20 | |
| | | - | - | 20 | - | - | 25 | |
| Reverse Dynamic Impedance I _R = 100 μA, T _A = +25°C | Z | - | 0.6 | - | - | 0.6 | - | Ω |
| Average Temperature Coefficient 20 μA ≤ I _R ≤ 20 mA, T _A = T _{low} to T _{high} (Note 2) | ΔV _(BR) /ΔT | - | 80 | - | - | 80 | - | ppm/°C |
| Wideband Noise (RMS) I _R = 100 μA, 10 Hz ≤ f ≤ 10 kHz | n | - | 120 | - | - | 120 | - | μV |
| Long Term Stability I _R = 100 μA, T _A = +25°C ± 0.1°C | S | - | 20 | - | - | 20 | - | ppm/kHR |

2. T_{low} = -40°C for LM285-1.2, LM285-2.5
 T_{high} = +85°C for LM285-1.2, LM285-2.5
 T_{low} = 0°C for LM385-1.2, LM385B-1.2, LM385-2.5, LM385B-2.5
 T_{high} = +70°C for LM385-1.2, LM385B-1.2, LM385-2.5, LM385B-2.5

LM285, LM385B

TYPICAL PERFORMANCE CURVES FOR LM285-1.2/385-1.2/385B-1.2



Figure 2. Reverse Characteristics

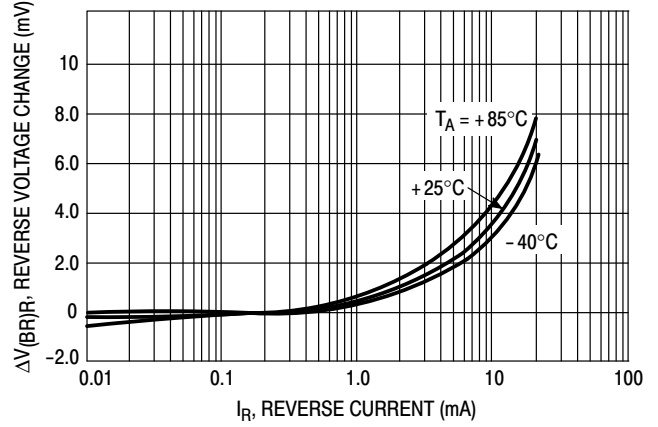


Figure 3. Reverse Characteristics



Figure 4. Forward Characteristics

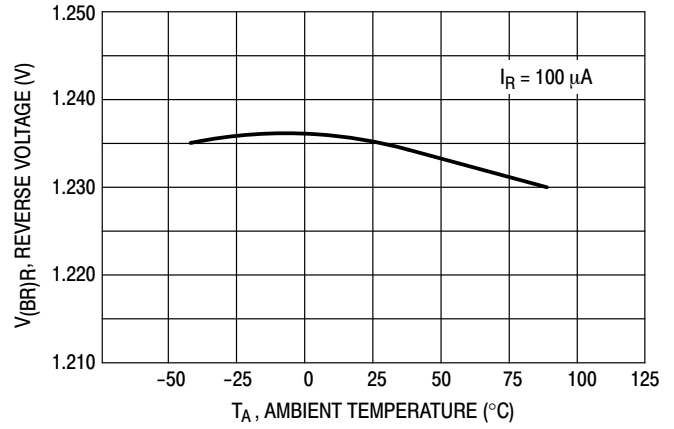


Figure 5. Temperature Drift

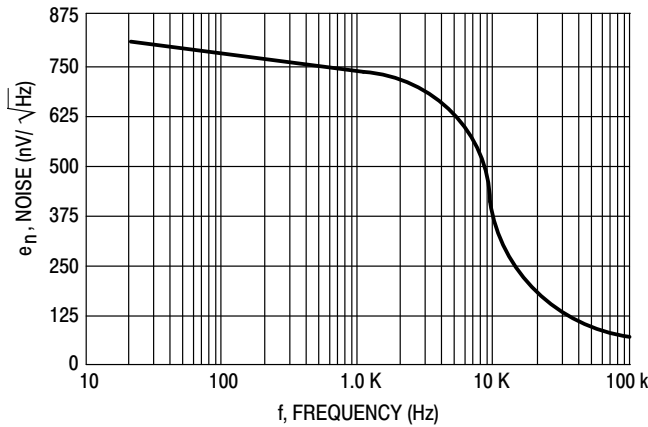


Figure 6. Noise Voltage

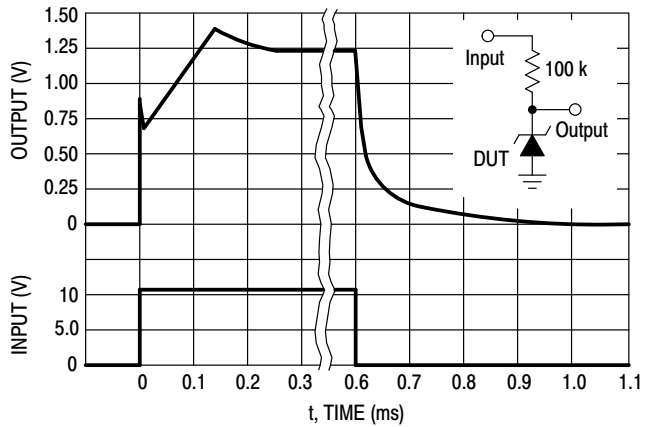


Figure 7. Response Time

LM285, LM385B

TYPICAL PERFORMANCE CURVES FOR LM285-2.5/385-2.5/385B-2.5

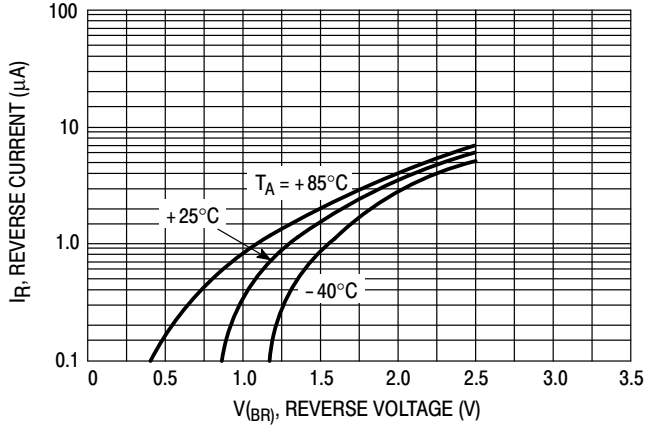


Figure 8. Reverse Characteristics

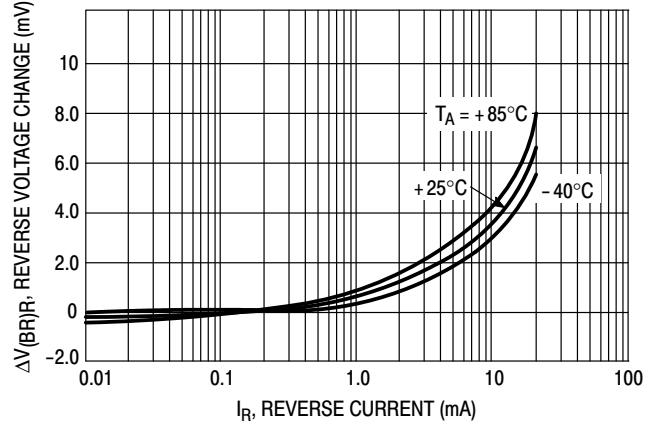


Figure 9. Reverse Characteristics

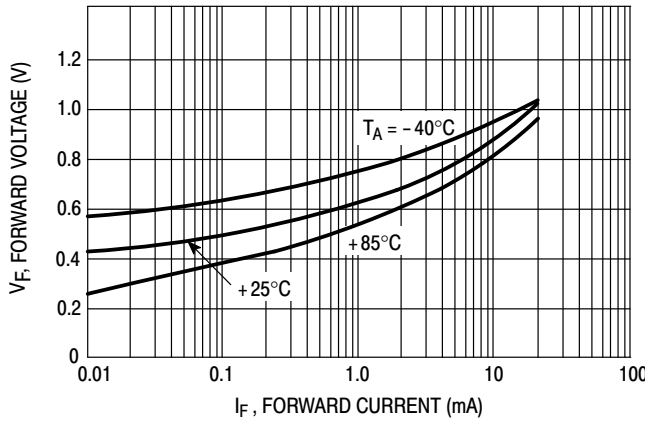


Figure 10. Forward Characteristics

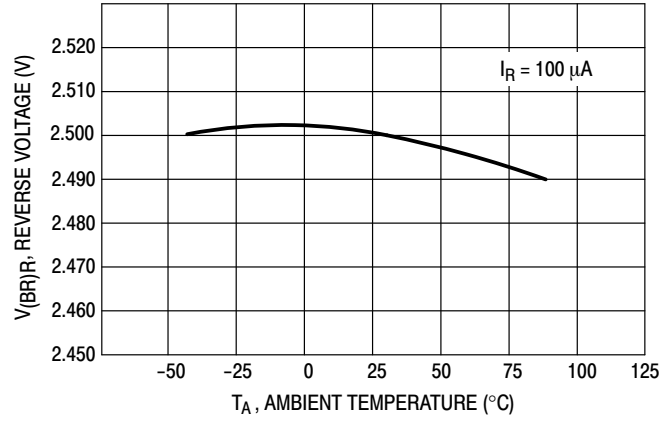


Figure 11. Temperature Drift

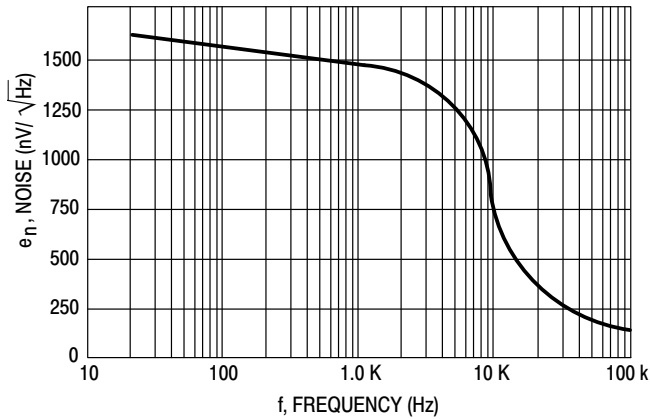


Figure 12. Noise Voltage

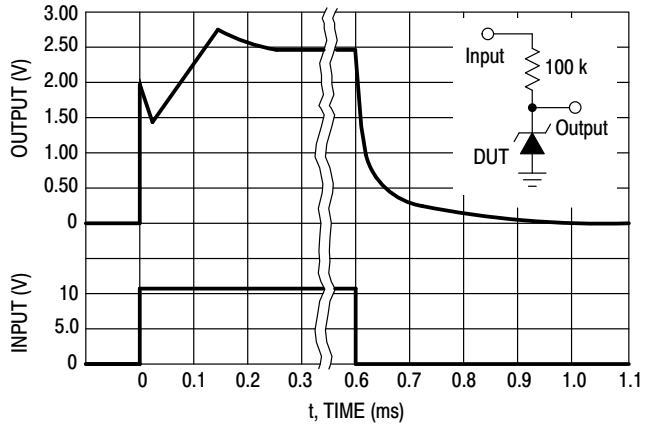


Figure 13. Response Time

LM285, LM385B

ORDERING INFORMATION

| Device | Operating Temperature Range | Reverse Break-Down Voltage | Package | Shipping [†] | |
|----------------|---------------------------------|---------------------------------|------------------|-----------------------|--------------------|
| LM285D-1.2 | T _A = -40°C to +85°C | 1.235 V | SOIC-8 | 98 Units / Rail | |
| LM285D-1.2G | | | SOIC-8 (Pb-Free) | 98 Units / Rail | |
| LM285D-1.2R2 | | | SOIC-8 | 2500 / Tape & Reel | |
| LM285D-1.2R2G | | | SOIC-8 (Pb-Free) | 2500 / Tape & Reel | |
| LM285D-2.5 | | 2.500 V | SOIC-8 | 98 Units / Rail | |
| LM285D-2.5G | | | SOIC-8 (Pb-Free) | 98 Units / Rail | |
| LM285D-2.5R2 | | | SOIC-8 | 2500 / Tape & Reel | |
| LM285D-2.5R2G | | | SOIC-8 (Pb-Free) | 2500 / Tape & Reel | |
| LM285Z-1.2 | | T _A = -40°C to +85°C | 1.235 V | TO-92 | 2000 Units / Bag |
| LM285Z-1.2G | | | | TO-92 (Pb-Free) | 2000 Units / Bag |
| LM285Z-2.5 | | | 2.500 V | TO-92 | 2000 Units / Bag |
| LM285Z-2.5G | | | | TO-92 (Pb-Free) | 2000 Units / Bag |
| LM285Z-1.2RA | | | 1.235 V | TO-92 | 2000 / Tape & Reel |
| LM285Z-1.2RAG | | | | TO-92 (Pb-Free) | 2000 / Tape & Reel |
| LM285Z-2.5RA | | | 2.500 V | TO-92 | 2000 / Tape & Reel |
| LM285Z-2.5RAG | | | | TO-92 (Pb-Free) | 2000 / Tape & Reel |
| LM285Z-2.5RP | TO-92 | | | 2000 Units / Fan-Fold | |
| LM285Z-2.5RPG | TO-92 (Pb-Free) | | | 2000 Units / Fan-Fold | |
| LM385BD-1.2 | T _A = 0°C to +70°C | | 1.235 V | SOIC-8 | 98 Units / Rail |
| LM385BD-1.2G | | | | SOIC-8 (Pb-Free) | 98 Units / Rail |
| LM385BD-1.2R2 | | | | SOIC-8 | 2500 / Tape & Reel |
| LM385BD-1.2R2G | | | | SOIC-8 (Pb-Free) | 2500 / Tape & Reel |
| LM385BD-2.5 | | | 2.500 V | SOIC-8 | 98 Units / Rail |
| LM385BD-2.5G | | | | SOIC-8 (Pb-Free) | 98 Units / Rail |
| LM385BD-2.5R2 | | SOIC-8 | | 2500 / Tape & Reel | |
| LM385BD-2.5R2G | | SOIC-8 (Pb-Free) | | 2500 / Tape & Reel | |
| LM385BZ-1.2 | | 1.235 V | TO-92 | 2000 Units / Bag | |
| LM385BZ-1.2G | | | TO-92 (Pb-Free) | 2000 Units / Bag | |
| LM385BZ-1.2RA | | | TO-92 | 2000 / Tape & Reel | |
| LM385BZ-1.2RAG | | | TO-92 (Pb-Free) | 2000 / Tape & Reel | |

[†]For information on tape and reel specifications, including part orientation and tape sizes, please refer to our Tape and Reel Packaging Specifications Brochure, BRD8011/D.

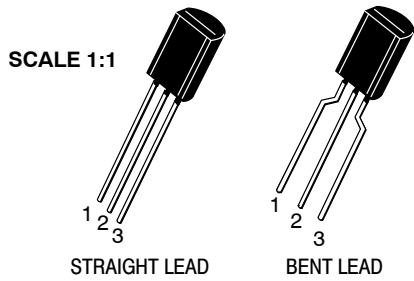
LM285, LM385B

ORDERING INFORMATION

| Device | Operating Temperature Range | Reverse Break-Down Voltage | Package | Shipping [†] |
|----------------|---|----------------------------|------------------|-----------------------|
| LM385BZ-2.5 | $T_A = 0^{\circ}\text{C to } +70^{\circ}\text{C}$ | 2.500 V | TO-92 | 2000 Units / Bag |
| LM385BZ-2.5G | | | TO-92 (Pb-Free) | 2000 Units / Bag |
| LM385BZ-2.5RA | | | TO-92 | 2000 / Tape & Reel |
| LM385BZ-2.5RAG | | | TO-92 (Pb-Free) | 2000 / Tape & Reel |
| LM385D-1.2 | | 1.235 V | SOIC-8 | 98 Units / Rail |
| LM385D-1.2G | | | SOIC-8 (Pb-Free) | 98 Units / Rail |
| LM385D-1.2R2 | | | SOIC-8 | 2500 / Tape & Reel |
| LM385D-1.2R2G | | | SOIC-8 (Pb-Free) | 2500 / Tape & Reel |
| LM385D-2.5 | | 2.500 V | SOIC-8 | 98 Units / Rail |
| LM385D-2.5G | | | SOIC-8 (Pb-Free) | 98 Units / Rail |
| LM385D-2.5R2 | | | SOIC-8 | 2500 / Tape & Reel |
| LM385D-2.5R2G | | | SOIC-8 (Pb-Free) | 2500 / Tape & Reel |
| LM385Z-1.2 | | 1.235 V | TO-92 | 2000 Units / Bag |
| LM385Z-1.2G | | | TO-92 (Pb-Free) | 2000 Units / Bag |
| LM385Z-1.2RA | | | TO-92 | 2000 / Tape & Reel |
| LM385Z-1.2RAG | | | TO-92 (Pb-Free) | 2000 / Tape & Reel |
| LM385Z-1.2RP | | | TO-92 | 2000 / Ammo Box |
| LM385Z-1.2RPG | | | TO-92 (Pb-Free) | 2000 / Ammo Box |
| LM385Z-2.5 | | 2.500 V | TO-92 | 2000 Units / Bag |
| LM385Z-2.5G | | | TO-92 (Pb-Free) | 2000 Units / Bag |
| LM385Z-2.5RP | TO-92 | | 2000 / Ammo Box | |
| LM385Z-2.5RPG | TO-92 (Pb-Free) | | 2000 / Ammo Box | |

[†]For information on tape and reel specifications, including part orientation and tape sizes, please refer to our Tape and Reel Packaging Specifications Brochure, BRD8011/D.

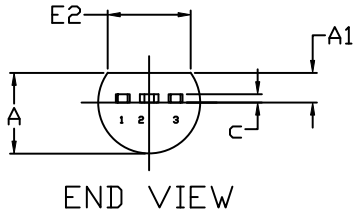
MECHANICAL CASE OUTLINE
PACKAGE DIMENSIONS



TO-92 (TO-226) 1 WATT
CASE 29-10
ISSUE D

DATE 05 MAR 2021

STRAIGHT LEAD



NOTES:

1. DIMENSIONING AND TOLERANCING PER ASME Y14.5M, 2009.
2. CONTROLLING DIMENSION: MILLIMETERS
3. DIMENSIONS D AND E DO NOT INCLUDE MOLD FLASH OR GATE PROTRUSIONS.
4. DIMENSION b AND b2 DOES NOT INCLUDE DAMBAR PROTRUSION. LEAD WIDTH INCLUDING PROTRUSION SHALL NOT EXCEED 0.20. DIMENSION b2 LOCATED ABOVE THE DAMBAR PORTION OF MIDDLE LEAD.



| DIM | MILLIMETERS | | |
|-----|-------------|-------|-------|
| | MIN. | NOM. | MAX. |
| A | 3.75 | 3.90 | 4.05 |
| A1 | 1.28 | 1.43 | 1.58 |
| b | 0.38 | 0.465 | 0.55 |
| b2 | 0.62 | 0.70 | 0.78 |
| c | 0.35 | 0.40 | 0.45 |
| D | 7.85 | 8.00 | 8.15 |
| E | 4.75 | 4.90 | 5.05 |
| E2 | 3.90 | --- | --- |
| e | 1.27 BSC | | |
| L | 13.80 | 14.00 | 14.20 |

STYLES AND MARKING ON PAGE 3

| | | |
|-------------------------|------------------------------|--|
| DOCUMENT NUMBER: | 98AON52857E | Electronic versions are uncontrolled except when accessed directly from the Document Repository. Printed versions are uncontrolled except when stamped "CONTROLLED COPY" in red. |
| DESCRIPTION: | TO-92 (TO-226) 1 WATT | PAGE 1 OF 3 |

ON Semiconductor and are trademarks of Semiconductor Components Industries, LLC dba ON Semiconductor or its subsidiaries in the United States and/or other countries. ON Semiconductor reserves the right to make changes without further notice to any products herein. ON Semiconductor makes no warranty, representation or guarantee regarding the suitability of its products for any particular purpose, nor does ON Semiconductor assume any liability arising out of the application or use of any product or circuit, and specifically disclaims any and all liability, including without limitation special, consequential or incidental damages. ON Semiconductor does not convey any license under its patent rights nor the rights of others.

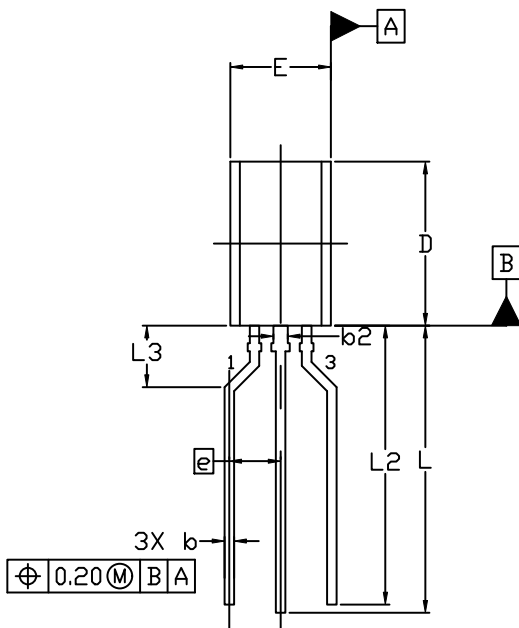
TO-92 (TO-226) 1 WATT
CASE 29-10
ISSUE D

DATE 05 MAR 2021

FORMED LEAD



END VIEW



TOP VIEW

NOTES:

1. DIMENSIONING AND TOLERANCING PER ASME Y14.5M, 2009.
2. CONTROLLING DIMENSION: MILLIMETERS
3. DIMENSIONS D AND E DO NOT INCLUDE MOLD FLASH OR GATE PROTRUSIONS.
4. DIMENSION b AND b2 DOES NOT INCLUDE DAMBAR PROTRUSION. LEAD WIDTH INCLUDING PROTRUSION SHALL NOT EXCEED 0.20. DIMENSION b2 LOCATED ABOVE THE DAMBAR PORTION OF MIDDLE LEAD.

| DIM | MILLIMETERS | | |
|-----|-------------|-------|-------|
| | MIN. | NOM. | MAX. |
| A | 3.75 | 3.90 | 4.05 |
| A1 | 1.28 | 1.43 | 1.58 |
| b | 0.38 | 0.465 | 0.55 |
| b2 | 0.62 | 0.70 | 0.78 |
| c | 0.35 | 0.40 | 0.45 |
| D | 7.85 | 8.00 | 8.15 |
| E | 4.75 | 4.90 | 5.05 |
| E2 | 3.90 | --- | --- |
| e | 2.50 BSC | | |
| L | 13.80 | 14.00 | 14.20 |
| L2 | 13.20 | 13.60 | 14.00 |
| L3 | 3.00 REF | | |

STYLES AND MARKING ON PAGE 3

| | | |
|-------------------------|------------------------------|--|
| DOCUMENT NUMBER: | 98AON52857E | Electronic versions are uncontrolled except when accessed directly from the Document Repository. Printed versions are uncontrolled except when stamped "CONTROLLED COPY" in red. |
| DESCRIPTION: | TO-92 (TO-226) 1 WATT | PAGE 2 OF 3 |

ON Semiconductor and  are trademarks of Semiconductor Components Industries, LLC dba ON Semiconductor or its subsidiaries in the United States and/or other countries. ON Semiconductor reserves the right to make changes without further notice to any products herein. ON Semiconductor makes no warranty, representation or guarantee regarding the suitability of its products for any particular purpose, nor does ON Semiconductor assume any liability arising out of the application or use of any product or circuit, and specifically disclaims any and all liability, including without limitation special, consequential or incidental damages. ON Semiconductor does not convey any license under its patent rights nor the rights of others.

**TO-92 (TO-226) 1 WATT
CASE 29-10
ISSUE D**

DATE 05 MAR 2021

- | | | | | |
|---|--|--|---|---|
| <p>STYLE 1: PIN 1. EMITTER 2. BASE 3. COLLECTOR</p> | <p>STYLE 2: PIN 1. BASE 2. EMITTER 3. COLLECTOR</p> | <p>STYLE 3: PIN 1. ANODE 2. ANODE 3. CATHODE</p> | <p>STYLE 4: PIN 1. CATHODE 2. CATHODE 3. ANODE</p> | <p>STYLE 5: PIN 1. DRAIN 2. SOURCE 3. GATE</p> |
| <p>STYLE 6: PIN 1. GATE 2. SOURCE & SUBSTRATE 3. DRAIN</p> | <p>STYLE 7: PIN 1. SOURCE 2. DRAIN 3. GATE</p> | <p>STYLE 8: PIN 1. DRAIN 2. GATE 3. SOURCE & SUBSTRATE</p> | <p>STYLE 9: PIN 1. BASE 1 2. EMITTER 3. BASE 2</p> | <p>STYLE 10: PIN 1. CATHODE 2. GATE 3. ANODE</p> |
| <p>STYLE 11: PIN 1. ANODE 2. CATHODE & ANODE 3. CATHODE</p> | <p>STYLE 12: PIN 1. MAIN TERMINAL 1 2. GATE 3. MAIN TERMINAL 2</p> | <p>STYLE 13: PIN 1. ANODE 1 2. GATE 3. CATHODE 2</p> | <p>STYLE 14: PIN 1. EMITTER 2. COLLECTOR 3. BASE</p> | <p>STYLE 15: PIN 1. ANODE 1 2. CATHODE 3. ANODE 2</p> |
| <p>STYLE 16: PIN 1. ANODE 2. GATE 3. CATHODE</p> | <p>STYLE 17: PIN 1. COLLECTOR 2. BASE 3. EMITTER</p> | <p>STYLE 18: PIN 1. ANODE 2. CATHODE 3. NOT CONNECTED</p> | <p>STYLE 19: PIN 1. GATE 2. ANODE 3. CATHODE</p> | <p>STYLE 20: PIN 1. NOT CONNECTED 2. CATHODE 3. ANODE</p> |
| <p>STYLE 21: PIN 1. COLLECTOR 2. EMITTER 3. BASE</p> | <p>STYLE 22: PIN 1. SOURCE 2. GATE 3. DRAIN</p> | <p>STYLE 23: PIN 1. GATE 2. SOURCE 3. DRAIN</p> | <p>STYLE 24: PIN 1. EMITTER 2. COLLECTOR/ANODE 3. CATHODE</p> | <p>STYLE 25: PIN 1. MT 1 2. GATE 3. MT 2</p> |
| <p>STYLE 26: PIN 1. V_{CC} 2. GROUND 2 3. OUTPUT</p> | <p>STYLE 27: PIN 1. MT 2. SUBSTRATE 3. MT</p> | <p>STYLE 28: PIN 1. CATHODE 2. ANODE 3. GATE</p> | <p>STYLE 29: PIN 1. NOT CONNECTED 2. ANODE 3. CATHODE</p> | <p>STYLE 30: PIN 1. DRAIN 2. GATE 3. SOURCE</p> |
| <p>STYLE 31: PIN 1. GATE 2. DRAIN 3. SOURCE</p> | <p>STYLE 32: PIN 1. BASE 2. COLLECTOR 3. EMITTER</p> | <p>STYLE 33: PIN 1. RETURN 2. INPUT 3. OUTPUT</p> | <p>STYLE 34: PIN 1. INPUT 2. GROUND 3. LOGIC</p> | <p>STYLE 35: PIN 1. GATE 2. COLLECTOR 3. EMITTER</p> |

**GENERIC
MARKING DIAGRAM***



- XXXX = Specific Device Code
 A = Assembly Location
 L = Wafer Lot
 Y = Year
 W = Work Week
 ▪ = Pb-Free Package

(Note: Microdot may be in either location)

*This information is generic. Please refer to device data sheet for actual part marking. Pb-Free indicator, "G" or microdot "▪", may or may not be present. Some products may not follow the Generic Marking.

| | | |
|-------------------------|------------------------------|--|
| DOCUMENT NUMBER: | 98AON52857E | Electronic versions are uncontrolled except when accessed directly from the Document Repository. Printed versions are uncontrolled except when stamped "CONTROLLED COPY" in red. |
| DESCRIPTION: | TO-92 (TO-226) 1 WATT | PAGE 3 OF 3 |

ON Semiconductor and  are trademarks of Semiconductor Components Industries, LLC dba ON Semiconductor or its subsidiaries in the United States and/or other countries. ON Semiconductor reserves the right to make changes without further notice to any products herein. ON Semiconductor makes no warranty, representation or guarantee regarding the suitability of its products for any particular purpose, nor does ON Semiconductor assume any liability arising out of the application or use of any product or circuit, and specifically disclaims any and all liability, including without limitation special, consequential or incidental damages. ON Semiconductor does not convey any license under its patent rights nor the rights of others.

MECHANICAL CASE OUTLINE PACKAGE DIMENSIONS

ON Semiconductor®



SCALE 1:1

SOIC-8 NB
CASE 751-07
ISSUE AK

DATE 16 FEB 2011



- NOTES:
1. DIMENSIONING AND TOLERANCING PER ANSI Y14.5M, 1982.
 2. CONTROLLING DIMENSION: MILLIMETER.
 3. DIMENSION A AND B DO NOT INCLUDE MOLD PROTRUSION.
 4. MAXIMUM MOLD PROTRUSION 0.15 (0.006) PER SIDE.
 5. DIMENSION D DOES NOT INCLUDE DAMBAR PROTRUSION. ALLOWABLE DAMBAR PROTRUSION SHALL BE 0.127 (0.005) TOTAL IN EXCESS OF THE D DIMENSION AT MAXIMUM MATERIAL CONDITION.
 6. 751-01 THRU 751-06 ARE OBSOLETE. NEW STANDARD IS 751-07.

| DIM | MILLIMETERS | | INCHES | |
|-----|-------------|------|-----------|-------|
| | MIN | MAX | MIN | MAX |
| A | 4.80 | 5.00 | 0.189 | 0.197 |
| B | 3.80 | 4.00 | 0.150 | 0.157 |
| C | 1.35 | 1.75 | 0.053 | 0.069 |
| D | 0.33 | 0.51 | 0.013 | 0.020 |
| G | 1.27 BSC | | 0.050 BSC | |
| H | 0.10 | 0.25 | 0.004 | 0.010 |
| J | 0.19 | 0.25 | 0.007 | 0.010 |
| K | 0.40 | 1.27 | 0.016 | 0.050 |
| M | 0° | 8° | 0° | 8° |
| N | 0.25 | 0.50 | 0.010 | 0.020 |
| S | 5.80 | 6.20 | 0.228 | 0.244 |

SOLDERING FOOTPRINT*



SCALE 6:1 (mm/inches)

*For additional information on our Pb-Free strategy and soldering details, please download the ON Semiconductor Soldering and Mounting Techniques Reference Manual, SOLDERRM/D.

GENERIC MARKING DIAGRAM*



XXXXXX = Specific Device Code
A = Assembly Location
L = Wafer Lot
Y = Year
W = Work Week
▪ = Pb-Free Package

XXXXXX = Specific Device Code
A = Assembly Location
Y = Year
WW = Work Week
▪ = Pb-Free Package

*This information is generic. Please refer to device data sheet for actual part marking. Pb-Free indicator, "G" or microdot "▪", may or may not be present. Some products may not follow the Generic Marking.

STYLES ON PAGE 2

| | | |
|------------------|-------------|--|
| DOCUMENT NUMBER: | 98ASB42564B | Electronic versions are uncontrolled except when accessed directly from the Document Repository. Printed versions are uncontrolled except when stamped "CONTROLLED COPY" in red. |
| DESCRIPTION: | SOIC-8 NB | PAGE 1 OF 2 |

ON Semiconductor and ON are trademarks of Semiconductor Components Industries, LLC dba ON Semiconductor or its subsidiaries in the United States and/or other countries. ON Semiconductor reserves the right to make changes without further notice to any products herein. ON Semiconductor makes no warranty, representation or guarantee regarding the suitability of its products for any particular purpose, nor does ON Semiconductor assume any liability arising out of the application or use of any product or circuit, and specifically disclaims any and all liability, including without limitation special, consequential or incidental damages. ON Semiconductor does not convey any license under its patent rights nor the rights of others.

SOIC-8 NB
CASE 751-07
ISSUE AK

DATE 16 FEB 2011

- | | | | |
|--|---|---|---|
| <p>STYLE 1: PIN 1. EMITTER 2. COLLECTOR 3. COLLECTOR 4. EMITTER 5. EMITTER 6. BASE 7. BASE 8. EMITTER</p> | <p>STYLE 2: PIN 1. COLLECTOR, DIE, #1 2. COLLECTOR, #1 3. COLLECTOR, #2 4. COLLECTOR, #2 5. BASE, #2 6. EMITTER, #2 7. BASE, #1 8. EMITTER, #1</p> | <p>STYLE 3: PIN 1. DRAIN, DIE #1 2. DRAIN, #1 3. DRAIN, #2 4. DRAIN, #2 5. GATE, #2 6. SOURCE, #2 7. GATE, #1 8. SOURCE, #1</p> | <p>STYLE 4: PIN 1. ANODE 2. ANODE 3. ANODE 4. ANODE 5. ANODE 6. ANODE 7. ANODE 8. COMMON CATHODE</p> |
| <p>STYLE 5: PIN 1. DRAIN 2. DRAIN 3. DRAIN 4. DRAIN 5. GATE 6. GATE 7. SOURCE 8. SOURCE</p> | <p>STYLE 6: PIN 1. SOURCE 2. DRAIN 3. DRAIN 4. SOURCE 5. SOURCE 6. GATE 7. GATE 8. SOURCE</p> | <p>STYLE 7: PIN 1. INPUT 2. EXTERNAL BYPASS 3. THIRD STAGE SOURCE 4. GROUND 5. DRAIN 6. GATE 3 7. SECOND STAGE Vd 8. FIRST STAGE Vd</p> | <p>STYLE 8: PIN 1. COLLECTOR, DIE #1 2. BASE, #1 3. BASE, #2 4. COLLECTOR, #2 5. COLLECTOR, #2 6. EMITTER, #2 7. EMITTER, #1 8. COLLECTOR, #1</p> |
| <p>STYLE 9: PIN 1. EMITTER, COMMON 2. COLLECTOR, DIE #1 3. COLLECTOR, DIE #2 4. EMITTER, COMMON 5. EMITTER, COMMON 6. BASE, DIE #2 7. BASE, DIE #1 8. EMITTER, COMMON</p> | <p>STYLE 10: PIN 1. GROUND 2. BIAS 1 3. OUTPUT 4. GROUND 5. GROUND 6. BIAS 2 7. INPUT 8. GROUND</p> | <p>STYLE 11: PIN 1. SOURCE 1 2. GATE 1 3. SOURCE 2 4. GATE 2 5. DRAIN 2 6. DRAIN 2 7. DRAIN 1 8. DRAIN 1</p> | <p>STYLE 12: PIN 1. SOURCE 2. SOURCE 3. SOURCE 4. GATE 5. DRAIN 6. DRAIN 7. DRAIN 8. DRAIN</p> |
| <p>STYLE 13: PIN 1. N.C. 2. SOURCE 3. SOURCE 4. GATE 5. DRAIN 6. DRAIN 7. DRAIN 8. DRAIN</p> | <p>STYLE 14: PIN 1. N-SOURCE 2. N-GATE 3. P-SOURCE 4. P-GATE 5. P-DRAIN 6. P-DRAIN 7. N-DRAIN 8. N-DRAIN</p> | <p>STYLE 15: PIN 1. ANODE 1 2. ANODE 1 3. ANODE 1 4. ANODE 1 5. CATHODE, COMMON 6. CATHODE, COMMON 7. CATHODE, COMMON 8. CATHODE, COMMON</p> | <p>STYLE 16: PIN 1. EMITTER, DIE #1 2. BASE, DIE #1 3. EMITTER, DIE #2 4. BASE, DIE #2 5. COLLECTOR, DIE #2 6. COLLECTOR, DIE #2 7. COLLECTOR, DIE #1 8. COLLECTOR, DIE #1</p> |
| <p>STYLE 17: PIN 1. VCC 2. V2OUT 3. V1OUT 4. TXE 5. RXE 6. VEE 7. GND 8. ACC</p> | <p>STYLE 18: PIN 1. ANODE 2. ANODE 3. SOURCE 4. GATE 5. DRAIN 6. DRAIN 7. CATHODE 8. CATHODE</p> | <p>STYLE 19: PIN 1. SOURCE 1 2. GATE 1 3. SOURCE 2 4. GATE 2 5. DRAIN 2 6. MIRROR 2 7. DRAIN 1 8. MIRROR 1</p> | <p>STYLE 20: PIN 1. SOURCE (N) 2. GATE (N) 3. SOURCE (P) 4. GATE (P) 5. DRAIN 6. DRAIN 7. DRAIN 8. DRAIN</p> |
| <p>STYLE 21: PIN 1. CATHODE 1 2. CATHODE 2 3. CATHODE 3 4. CATHODE 4 5. CATHODE 5 6. COMMON ANODE 7. COMMON ANODE 8. CATHODE 6</p> | <p>STYLE 22: PIN 1. I/O LINE 1 2. COMMON CATHODE/VCC 3. COMMON CATHODE/VCC 4. I/O LINE 3 5. COMMON ANODE/GND 6. I/O LINE 4 7. I/O LINE 5 8. COMMON ANODE/GND</p> | <p>STYLE 23: PIN 1. LINE 1 IN 2. COMMON ANODE/GND 3. COMMON ANODE/GND 4. LINE 2 IN 5. LINE 2 OUT 6. COMMON ANODE/GND 7. COMMON ANODE/GND 8. LINE 1 OUT</p> | <p>STYLE 24: PIN 1. BASE 2. EMITTER 3. COLLECTOR/ANODE 4. COLLECTOR/ANODE 5. CATHODE 6. CATHODE 7. COLLECTOR/ANODE 8. COLLECTOR/ANODE</p> |
| <p>STYLE 25: PIN 1. VIN 2. N/C 3. REXT 4. GND 5. IOUT 6. IOUT 7. IOUT 8. IOUT</p> | <p>STYLE 26: PIN 1. GND 2. dv/dt 3. ENABLE 4. ILIMIT 5. SOURCE 6. SOURCE 7. SOURCE 8. VCC</p> | <p>STYLE 27: PIN 1. ILIMIT 2. OVLO 3. UVLO 4. INPUT+ 5. SOURCE 6. SOURCE 7. SOURCE 8. DRAIN</p> | <p>STYLE 28: PIN 1. SW_TO_GND 2. DASIC OFF 3. DASIC_SW_DET 4. GND 5. V_MON 6. VBULK 7. VBULK 8. VIN</p> |
| <p>STYLE 29: PIN 1. BASE, DIE #1 2. EMITTER, #1 3. BASE, #2 4. EMITTER, #2 5. COLLECTOR, #2 6. COLLECTOR, #2 7. COLLECTOR, #1 8. COLLECTOR, #1</p> | <p>STYLE 30: PIN 1. DRAIN 1 2. DRAIN 1 3. GATE 2 4. SOURCE 2 5. SOURCE 1/DRAIN 2 6. SOURCE 1/DRAIN 2 7. SOURCE 1/DRAIN 2 8. GATE 1</p> | | |

| | | |
|-------------------------|--------------------|---|
| DOCUMENT NUMBER: | 98ASB42564B | Electronic versions are uncontrolled except when accessed directly from the Document Repository. Printed versions are uncontrolled except when stamped "CONTROLLED COPY" in red. |
| DESCRIPTION: | SOIC-8 NB | PAGE 2 OF 2 |

ON Semiconductor and  are trademarks of Semiconductor Components Industries, LLC dba ON Semiconductor or its subsidiaries in the United States and/or other countries. ON Semiconductor reserves the right to make changes without further notice to any products herein. ON Semiconductor makes no warranty, representation or guarantee regarding the suitability of its products for any particular purpose, nor does ON Semiconductor assume any liability arising out of the application or use of any product or circuit, and specifically disclaims any and all liability, including without limitation special, consequential or incidental damages. ON Semiconductor does not convey any license under its patent rights nor the rights of others.

onsemi, **Onsemi**, and other names, marks, and brands are registered and/or common law trademarks of Semiconductor Components Industries, LLC dba "**onsemi**" or its affiliates and/or subsidiaries in the United States and/or other countries. **onsemi** owns the rights to a number of patents, trademarks, copyrights, trade secrets, and other intellectual property. A listing of **onsemi**'s product/patent coverage may be accessed at www.onsemi.com/site/pdf/Patent-Marking.pdf. **onsemi** reserves the right to make changes at any time to any products or information herein, without notice. The information herein is provided "as-is" and **onsemi** makes no warranty, representation or guarantee regarding the accuracy of the information, product features, availability, functionality, or suitability of its products for any particular purpose, nor does **onsemi** assume any liability arising out of the application or use of any product or circuit, and specifically disclaims any and all liability, including without limitation special, consequential or incidental damages. Buyer is responsible for its products and applications using **onsemi** products, including compliance with all laws, regulations and safety requirements or standards, regardless of any support or applications information provided by **onsemi**. "Typical" parameters which may be provided in **onsemi** data sheets and/or specifications can and do vary in different applications and actual performance may vary over time. All operating parameters, including "Typicals" must be validated for each customer application by customer's technical experts. **onsemi** does not convey any license under any of its intellectual property rights nor the rights of others. **onsemi** products are not designed, intended, or authorized for use as a critical component in life support systems or any FDA Class 3 medical devices or medical devices with a same or similar classification in a foreign jurisdiction or any devices intended for implantation in the human body. Should Buyer purchase or use **onsemi** products for any such unintended or unauthorized application, Buyer shall indemnify and hold **onsemi** and its officers, employees, subsidiaries, affiliates, and distributors harmless against all claims, costs, damages, and expenses, and reasonable attorney fees arising out of, directly or indirectly, any claim of personal injury or death associated with such unintended or unauthorized use, even if such claim alleges that **onsemi** was negligent regarding the design or manufacture of the part. **onsemi** is an Equal Opportunity/Affirmative Action Employer. This literature is subject to all applicable copyright laws and is not for resale in any manner.

PUBLICATION ORDERING INFORMATION

LITERATURE FULFILLMENT:

Email Requests to: orderlit@onsemi.com

onsemi Website: www.onsemi.com

TECHNICAL SUPPORT

North American Technical Support:

Voice Mail: 1 800-282-9855 Toll Free USA/Canada

Phone: 011 421 33 790 2910

Europe, Middle East and Africa Technical Support:

Phone: 00421 33 790 2910

For additional information, please contact your local Sales Representative

Mouser Electronics

Authorized Distributor

Click to View Pricing, Inventory, Delivery & Lifecycle Information:

[onsemi:](#)

[LM285D-1.2](#) [LM285D-1.2G](#) [LM285D-1.2R2](#) [LM285D-1.2R2G](#) [LM285D-2.5](#) [LM285D-2.5G](#) [LM285D-2.5R2](#)
[LM285D-2.5R2G](#) [LM285Z-1.2](#) [LM285Z-1.2G](#) [LM285Z-1.2RA](#) [LM285Z-1.2RAG](#) [LM285Z-2.5](#) [LM285Z-2.5G](#) [LM285Z-2.5RA](#) [LM285Z-2.5RAG](#) [LM285Z-2.5RP](#) [LM285Z-2.5RPG](#) [LM385BD-1.2](#) [LM385BD-1.2G](#) [LM385BD-1.2R2](#)
[LM385BD-1.2R2G](#) [LM385BD-2.5](#) [LM385BD-2.5G](#) [LM385BD-2.5R2](#) [LM385BD-2.5R2G](#) [LM385BZ-1.2](#) [LM385BZ-1.2G](#)
[LM385BZ-1.2RA](#) [LM385BZ-2.5](#) [LM385BZ-2.5RA](#) [LM385D-1.2](#) [LM385D-1.2G](#) [LM385D-1.2R2](#) [LM385D-1.2R2G](#)
[LM385D-2.5](#) [LM385D-2.5G](#) [LM385D-2.5R2](#) [LM385D-2.5R2G](#) [LM385Z-1.2](#) [LM385Z-1.2G](#) [LM385Z-1.2RA](#) [LM385Z-1.2RAG](#) [LM385Z-1.2RP](#) [LM385Z-1.2RPG](#) [LM385Z-2.5](#) [LM385Z-2.5G](#) [LM385Z-2.5RP](#) [LM385Z-2.5RPG](#) [LM385BZ-1.2RAG](#) [LM385BZ-2.5G](#) [LM385BZ-2.5RAG](#)